

OPERATION MANUAL



Digital Readouts

Model. DPD-300i

EDITION No : DPD-300i -1
DATE OF ISSUE : 11/2023

MACHINE DETAILS

MACHINE	<input type="text" value="Digital Readout"/>
MODEL NO.	<input type="text" value="DPD-300i"/>
SERIAL NO.	<input type="text"/>
DATE OF MANF.	<input type="text"/>

DISTRIBUTED BY

www.machineryhouse.com.auwww.machineryhouse.co.nz**NOTE:**

This manual is only for your reference. At the time of the compiling of this manual every effort to be exact with the instructions, specifications, drawings, and photographs of the machine was taken. Owing to the continuous improvement of the HAFCO METALMASTER equipment, changes may be made at any time without obligation or notice. Please ensure the local voltage is the same as listed on the specification plate before operating any electric machine.

POWER SUPPLY

The PROTECTIVE EARTH CIRCUIT of the mains supply, MUST BE CONNECTED to the protective earth terminal of the DRO through the supply cord.

The supply cord must be secured with cable ties to avoid from dropping into a hazardous position, for example the floor or coolant tray, when disconnected from the DRO.

The supply cord must be routed away from moving parts, swarf, coolant or sources of heat.

MOUNTING

Select the location of the installation with due regard of safety and ease of operation. Keep the DRO away of moving parts and coolant spray. To ensure correct operation of the DRO, make sure that the DRO is correct grounding. The DRO may require grounding if different power circuits are used. Grounding diagram can be found on page 28

CONTENTS:

1. Identification	
1.1 The Front Panel	5
1.2 The Front Panel Identification	6
1.3 Rear Panel	7
1.4 Identification Summary	7
1.5 Function Options	8
1.6 Coordinate System	9
2. Basic Operation	10
2.1 Power On	10
2.2 Zeroing The Axis	10
2.3 Enter a Dimension in an Axis	10
2.4 Screen Enlargement	11
2.5 Metric to Inch Conversion	11
2.6 Absolute / Incremental	12
2.7 Lathe Function	13
2.8 Toggle Between R/D Display Mode	14
2.9 Calculation Function	15
2.10 Calculating The Mid Point	16
3. Special Functions	17
3.1 Pitch Hole Function	17
3.2 Bolt Hole Line Function	19
3.3 Arc Machining	20
3.4 Angle Display Type	21
3.5 Setting The Input In SDM Coordinate	22
4. Setup	23
4.1 Setting The Type Of DRO	23
Function Options	24
DPA Display Set	25
4.2 The Scale Reference Point	26
4.3 Troubleshooting	27
Grounding Diagram	28

DPD-300i DIGITAL READOUT

Digital readouts are used in a wide variety of applications. These include machine tools, in-feed axes, measuring and inspection equipment, EDM, dividing apparatuses, setting tools, and measuring stations for production control. In order to meet the requirements of these applications, many encoders can be connected to the digital readouts. Read all the instructions in the manual carefully and strictly follow them before using the equipment. Keep the manual for future references.

SAFETY ATTENTION:

1. To prevent electric shock or fire, moisture or directly sprayed cooling liquid must be avoided. In cases where there is smoke or a peculiar smell from the digital readout, please unplug the power plug immediately. All care must be taken as fire or electric shock can be caused. In such a case, do not try to repair the digital readout but please contact your distributor.
2. A Digital readout is a precise measuring device used with an optical Linear Scale. When it is in use, if the connection between the Linear Scale and the digital readout is broken or damaged externally, incorrect measuring values may be the result. Therefore, the user should be careful if damage does occur.
3. Do not try to repair or modify the digital readout as failure, fault or injury may occur. In case of any abnormal condition, please contact your distributor.
4. If the optical Linear Scale used with the digital readout is damaged, do not replace it with a Linear Scale of another brand. The performance, specification and connection of the product may be different and can not be connected without the instruction of specialized technical personnel, Problems can be caused to the digital readout and scale if they are not compatible.
5. The operating safety of this digital readout display was tested prior to leaving the factory. It has been designed and built using the latest technological advances. There still remains a slight risk since the device operates with electrical voltages and currents. Manufacturing construction resources and safety techniques have been used to minimize the risk to operating personnel resulting from this hazard. If the device is operated or maintained by personnel who are not qualified, there may be a risk resulting from incorrect operation or improper maintenance.



WARNING

Always disconnect the power to the machine before servicing or doing maintenance to the machine.

Chaper 1 IDENTIFICATION

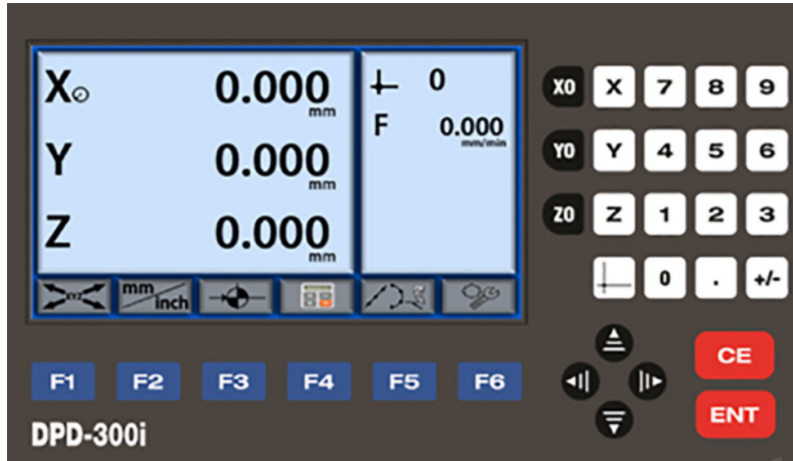

1.1 THE FRONT PANEL



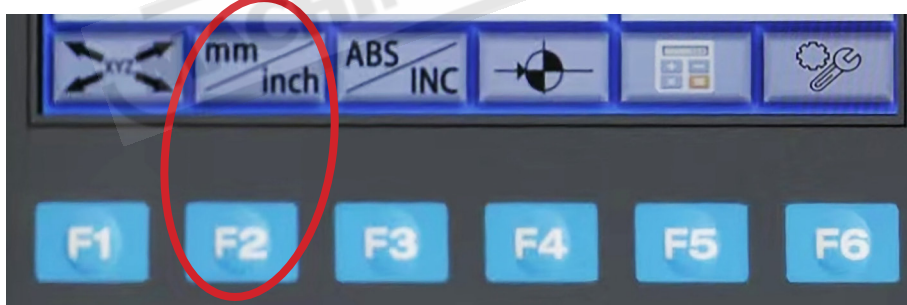

NOTE: The digital display area of the front panel is not touch sensitive and any option on the screen requires an entry by a button.

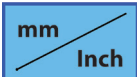

Example:

To select  press the button below 

To select  press the button below 

1.2 THE FRONT PANEL IDENTIFICATION

Become familiar with the names and locations of the controls and features shown below to better understand the instructions when mentioned later in this manual.

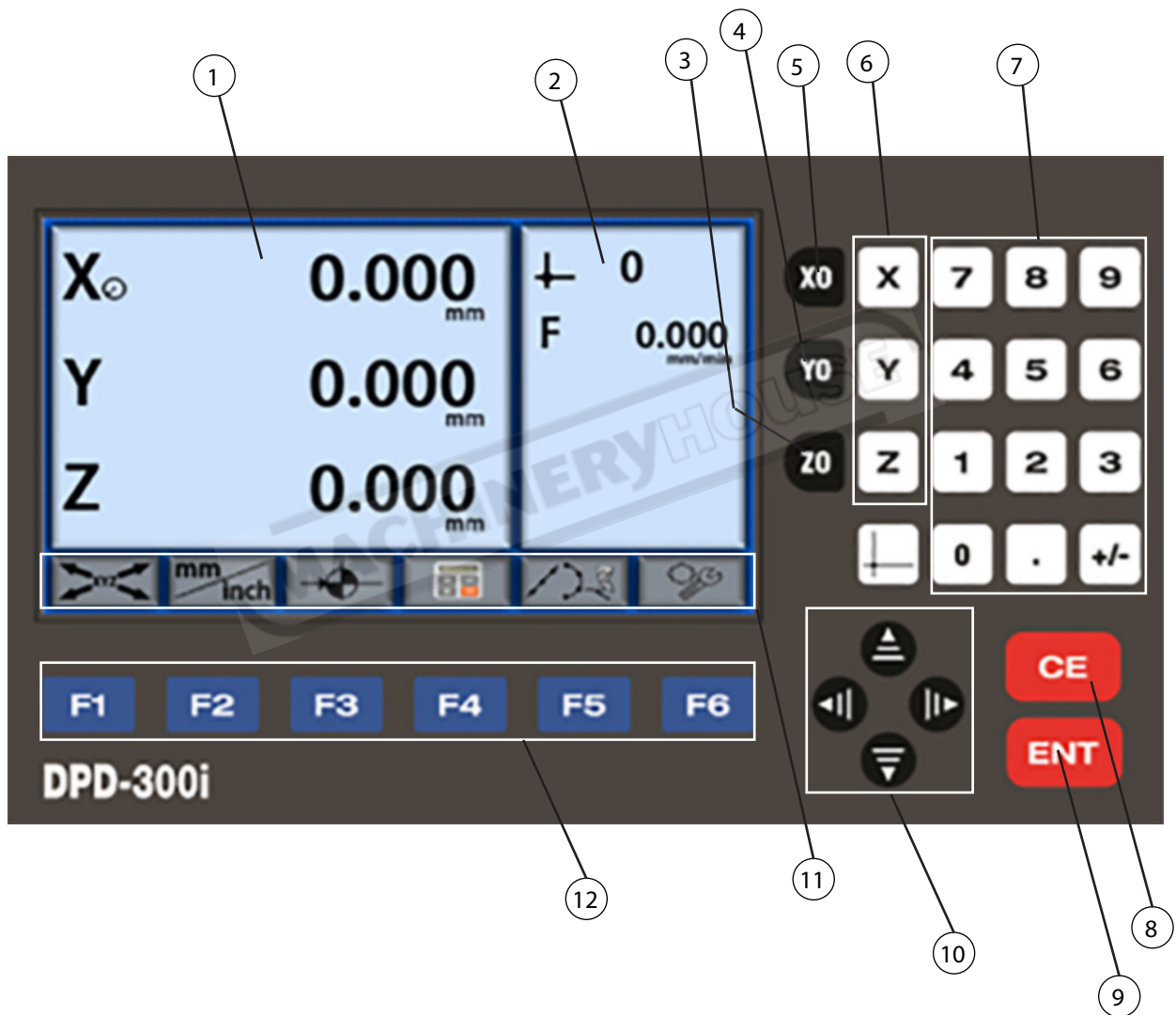

1.3 REAR PANEL



1.4 IDENTIFICATION SUMMARY

Become familiar with the names and locations of the controls and features shown on previous pages to better understand the instructions if mentioned later in this manual.

1	LCD Screen: Axis Display Section
2	Operation Function: Information
3	Z0 Zero,s the Z axis (0.000)
4	Y0 Zero,s the Y axis (0.000)
5	X0 Zero,s the X axis (0.000)

1.4 IDENTIFICATION SUMMARY Cont.

6	X, Y, Z Keys: Select each Axis when changes need to be made.
7	Numeric Keys 1 ~ 0 , Decimal Point and + and - Selection
8	CE Key: Clears the operation selected
9	ENT Key: Confirms selected operation
10	Arrow Keys : Moves the Cursor around the LCD
11	Function Options : Displays Options available.
12	Select Function Keys F1 - F6 : Selects the function directly above the key
13	ON / OFF Switch : Powers up the DRO
14	Power Socket : Accepts a 240 Volt, 10amp power lead
15	Grounding Point : Grounds the DRO to the machine
16	Socket Panel ; Connection points for the scales.

1.5 FUNCTION OPTIONS

The following copy of the Function Menu display and table of contents is a list of available Function Options for the DPD-300i Digital Readout.

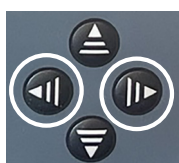

Press the right or left arrows to change between the menu



1.6 COORDINATE SYSTEM

The **HAFCO DPD-300i** DRO is an instrument which can measure the position of the work piece when processing. For more efficiency and accuracy, the coordinate system needs to be defined first.

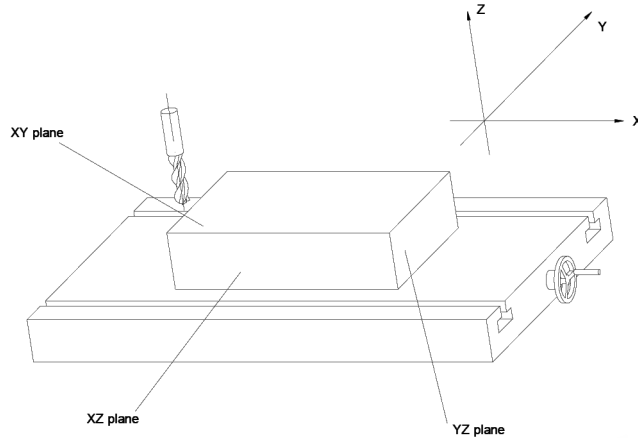

On a vertical milling machine, the longitudinal travel of the table is parallel with the X axis, and cross travel is parallel with the Y axis. Z is parallel to the spindle and is parallel to the up-and-down travel. Origin is a point along the axis that reads zero. Positive direction of an axis is set as the number increases as you move away from the origin. The value of one point position is the distance relative to the origin of the coordinate. For a work-piece as Figure A, the value of each point position is as Figure B when point O is the origin of the coordinate.

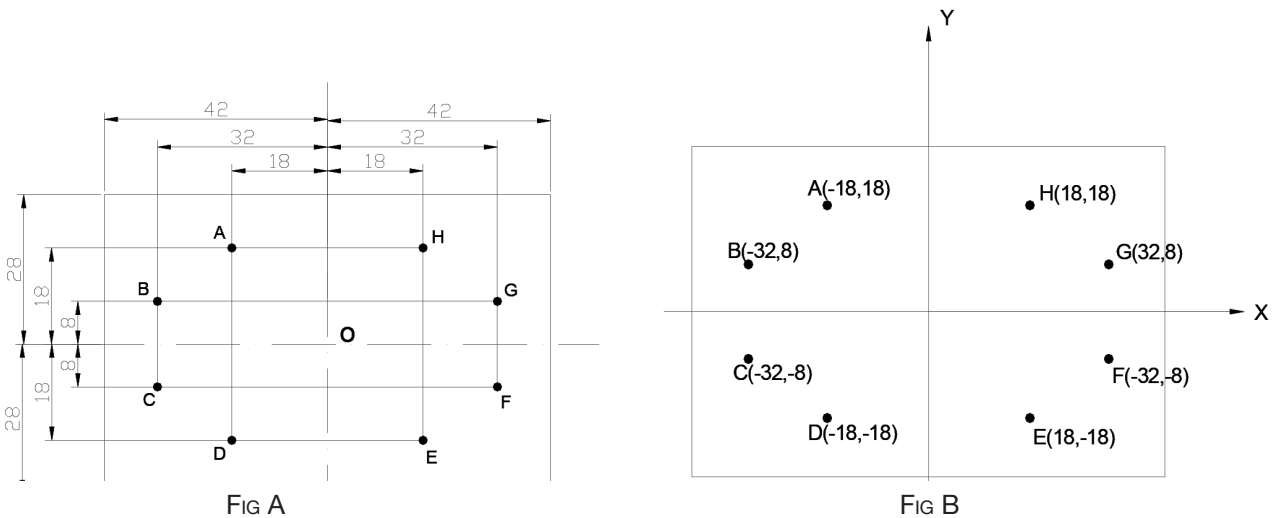

Chapter 2. BASIC OPERATION

2.1 POWER ON

When the **DPD-300i** is Powered up it enters the normal display state, and memorizes the following parameters.

- A. The scales position when the power was switched off.
- B. The mode selection when powered off (ABS/INC/SDM)
- C. The Metric/Imperial mode when switched off.

2.2 ZEROING THE AXIS

The purpose of this function is to set the current position for that axis to ZERO

Example : Setting the current X axis position to ZERO.

The same process is used for the “Y Axis” and the “Z Axis”

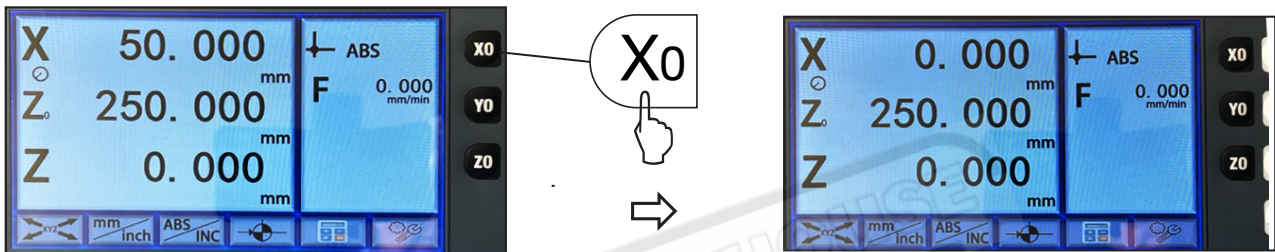

2.3 ENTER A DIMENSION IN AN AXIS

Function: Enter a value for an axis in normal display state.

NOTE: An Axis value cannot be preset while the DRO is in other states (e.g. calculating function or special function).

Press the **X0** then press **X**. The “X” will flash, press the 1 and 2 and select “+” or “-”. If the value is incorrect press **CE** to cancel and input again. When the value is correct then press **ENT** to confirm the entry.

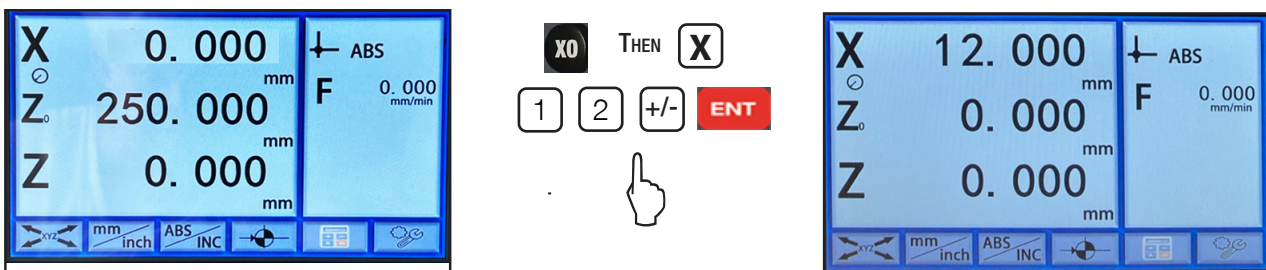

2.4 SCREEN ENLARGEMENT

This function is used to enlarge the screen by removing the operation Function section of the LCD to allow the Axis display to be larger.

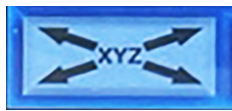

Press F1 to select enlarge screen

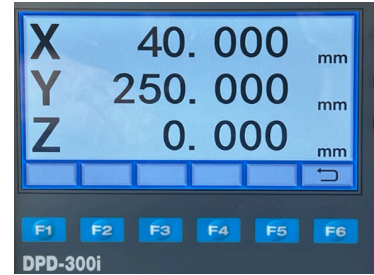
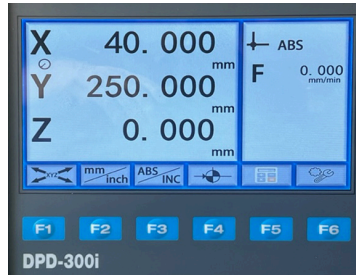

2.5 METRIC TO INCH CONVERSION

The purpose of this function is to switch the display between Inch or Metric

EXAMPLE 1. METRIC TO INCH

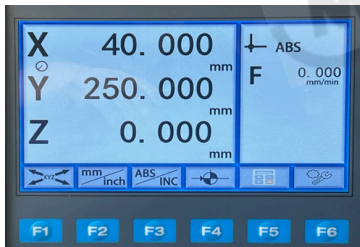

EXAMPLE 1. INCH TO METRIC

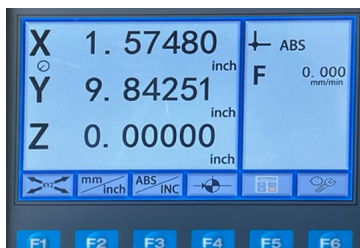

2.6 ABSOLUTE / INCREMENTAL

An ABSOLUTE movement moves to a measurement distance from the ZERO POINT.

An INCREMENTAL movement is a measurement based on the current position. An incremental measurement does not take the parts zero point into consideration.

During machining operations, the operator can store the work piece datum (ZERO position) in ABS coordinate, then switch to INC coordinate to continue machining operations.

Then the operator is free then to zero the axes or preset any dimensions into any axis in INC coordinate for any relative position machining. The work piece datum (work piece ZERO position) is still kept in the ABS coordinate of the DRO.

Function: The HAFCO DPD-300i DRO has 3 display modes, absolute mode (ABS), incremental mode (INC) and 100 group Second Data Memory (SDM) with the range of 000 to 199.

1. Zero point of the work-piece is set at the origin point of the ABS coordinate,
2. The relative distance between datum of ABS and SDM remains unchanged when ABS datum is changed.
3. If one point in ABS is zeroed, the point in INC is zeroed automatically, yet if one point in INC is zeroed, the point in ABS will remain unchanged.

Example: Currently in ABS display coordinate, to switch to INC display coordinate.

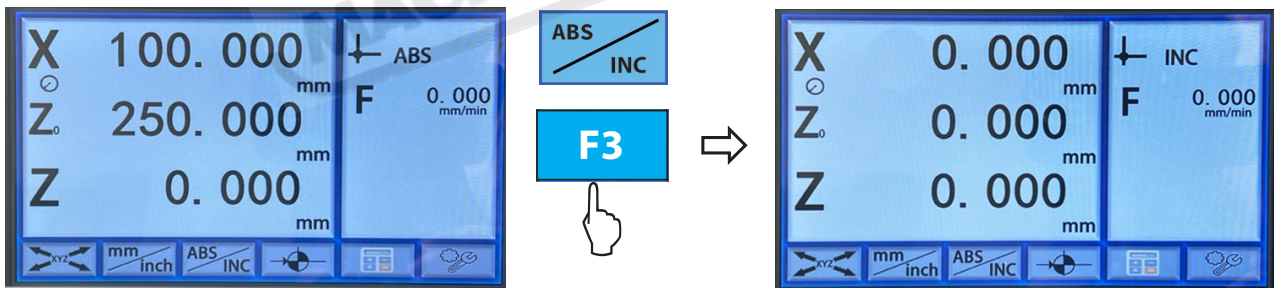

While in “INC” mode to enter a value in “X” press **X** and X will begin to flash. As a value is entered the value will change to Red. Example: With the numeric keyboard enter 10.000

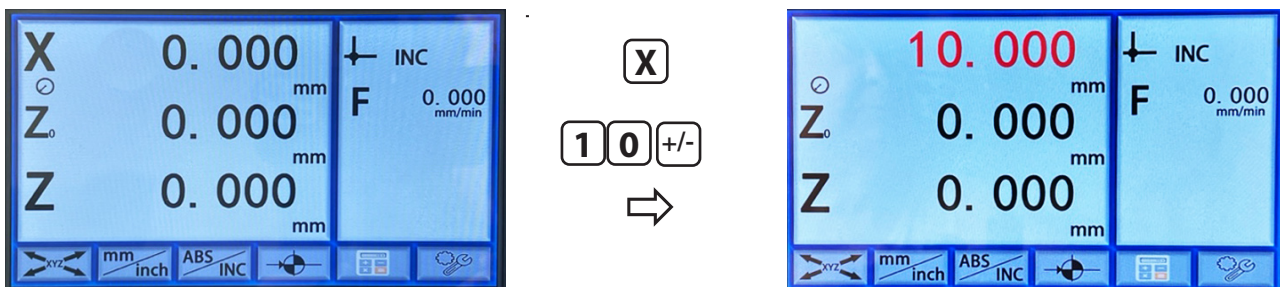

2.6 ABSOLUTE / INCREMENTAL Cont.

If the value is incorrect press **CE** to cancel and input again. When the value is correct then press **ENT** to confirm the entry. Then press **X** to return to the “INC” screen. Once the scale has been moved to 0.000mm and the ABS screen is selected again the value in Absolute will include the value of the Incremental entry.

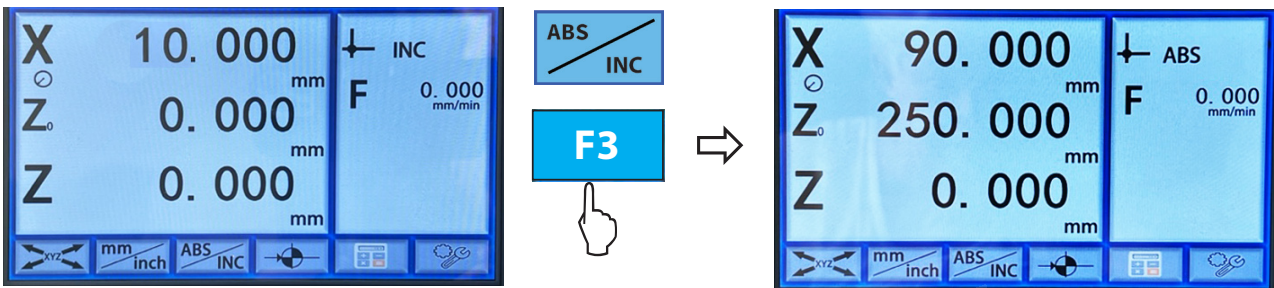

2.7 LATHE FUNCTIONS

2 AXIS SCALES

When normal 2 axis lathe function is required, the DRO should be set up as per the image to the right. (See Page 23 for Setup) The DRO can be set up with the “X” axis fitted to the cross slide and “Z” axis setup as the longitudinal axis fitted to the bed of the lathe.

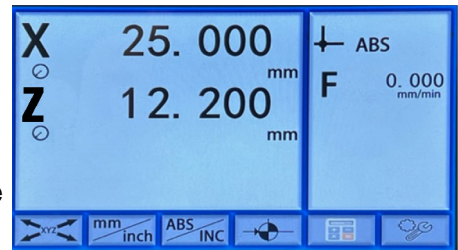

3 AXIS SCALES

When 3 axis setup is used the scales are setup as per the image to the right, This allows for two scales to be installed on the one axis, the position of the work-piece length should then be the sum of these two values (Z+Z0) in this direction.

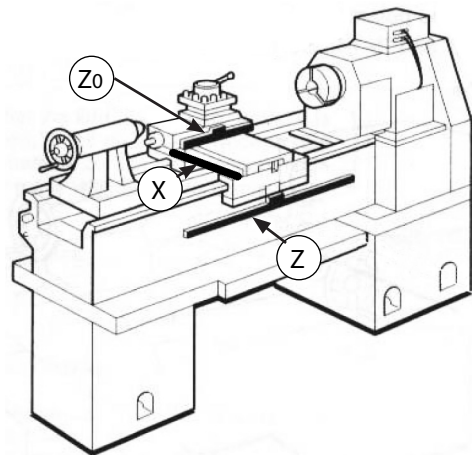

When in 3 axis Lathe mode:

- X window value = the value of the diameter.
- Z window value = the value of Z axis position + the value of Z0 axis position.

2.7 LATHE FUNCTIONS Cont.

To set the Lathe function using 3 scales the DRO must be set up as per the diagram to the right, with an “X” axis scale on the cross slide to measure diameter and the “Z₀” axis scale on the top slide and the Z axis, the main longitudinal axis.

NOTE: To set the DRO to the lathe format see page 24 under “Setup”

Steps:

1. Set the lathe mode in initial system settings.
2. In normal display state the DRO will be set up as per image to the right
3. Press  to reveal the lathe functions menus.

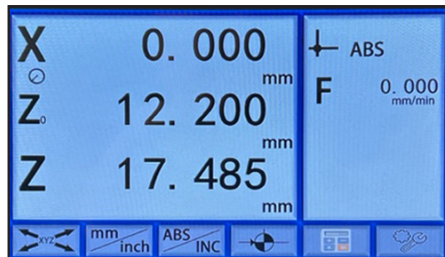

4. Press **F2** to select **Z+Z₀** to add “Z₀” axis to the value of the “Z” axis.

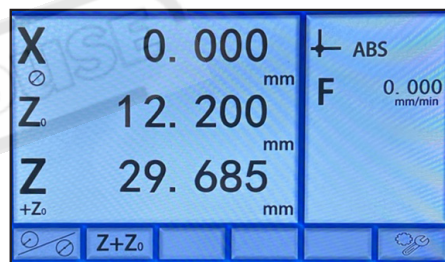
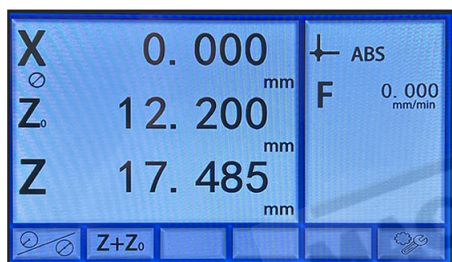

2.8 TOGGLE BETWEEN R/D DISPLAY MODE

The display value is the distance between lathe tool and the workpiece origin. This display default mode of the DRO is a radius mode. When turning a cylinder the given diameter measurement, is double the distance between the lathe tool and the workpiece datum. To use the DRO with the display showing the diameter, the DRO needs set to the diameter mode.

Steps:

4. Press **F1** to select  to change the “X” axis from radius to diameter.

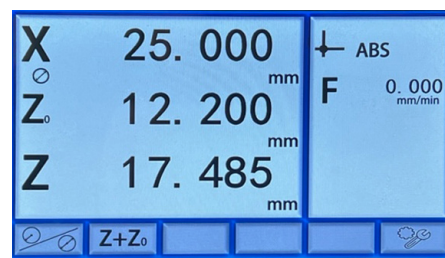
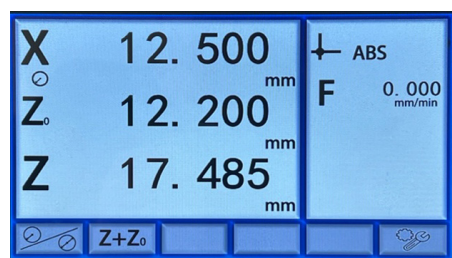

2.9 CALCULATOR FUNCTION

The DPD-300i provides an internal calculator for operations such as plus, minus, multiply and divide, which is convenient for the operator when processing work piece according to the drawing.

ENTER AND EXIT CALCULATOR FUNCTION

In normal display state: press **F5** to select  the calculator function.

The menu for the calculator will appear.



In calculator state: press **F6** to select  to exit the calculator function.

Example

Example 1: $123 + 76 \times 58 - 892 / 63$



Note:

1. If the incorrect data is entered, press **CE** to cancel and enter again.
2. The absolute value of entered data and calculated result should be in the range of 0.001 to 99999.9 otherwise it cannot be displayed.

TRANSFERRING THE CALCULATED RESULTS TO SELECTED AXIS

After calculating is finished:

Press **X** to transfer the calculated result to the X axis. The X window will now display this value,

Press **Y** to transfer the calculated result to the Y axis. The Y window will now display this value,

Press **Z** to transfer the calculated result to the Z axis. The Z window will now display this value.

Note: The calculated data can not be transferred if it is out of the displays range.

2.10 CALCULATING THE MID POINT

Function: Set the center of the work piece as datum by halving the displayed value.

To set the current X axis zero position at the centre of the work piece,

Step 1. Using an edge finder locate the edge at one end of the work piece, then zero the X axis.

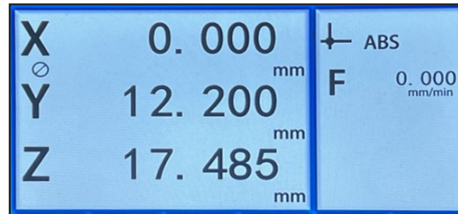
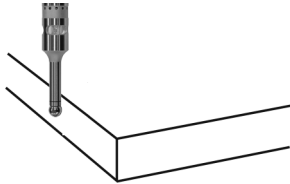

Step 2. Using the edge finder locate the edge at the other end of the work piece.

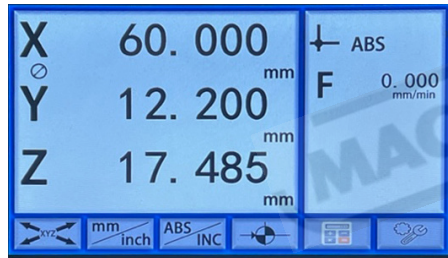
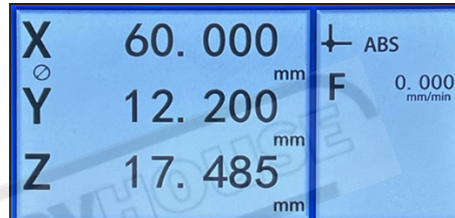
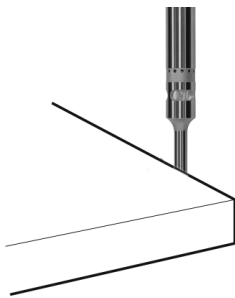

Step 3. In normal display state: press **F5** to select the calculator function.

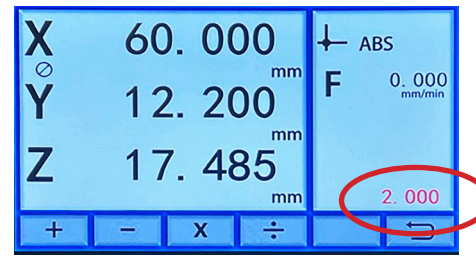
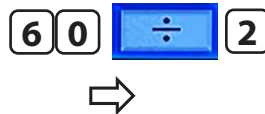
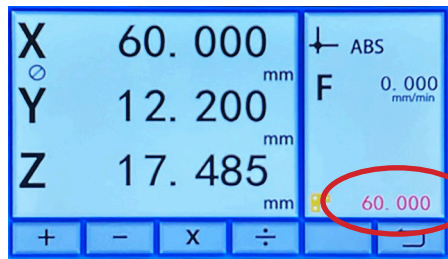

To result can be transfer and replace the value in either. This can be done by pressing the axis the value needs to replace. Then press **F6** to select the transfer function.

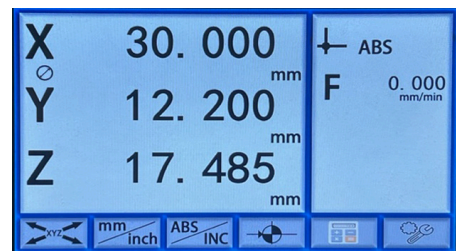
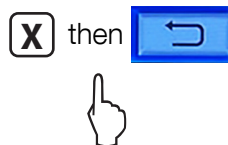
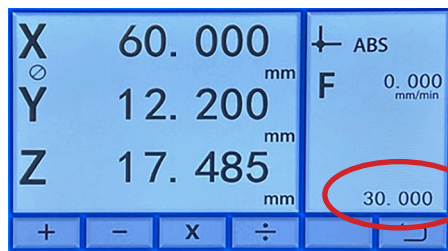

Chapter 3. SPECIAL FUNCTIONS

The **HAFCO DPD-300i** series DRO has special functions as well as measuring and positioning. These are only available when the DRO is setup for the “MILL” function.

- 4.1 Pitch Circle Hole Function
- 4.2 Bolt Hole Line Function
- 4.3 Arc Machining
- 4.4 Slope Machining Function

3.1 PITCH CIRCLE HOLE FUNCTION

Function description:

The DPD-300i series DRO has a Pitch Circle Hole Function. This function can simplify the pressing of multiple holes which are attributed equally around the circumference of a circle. The DRO will guide operator to enter the following parameters:

- COORDINATE PLANE: - X & Y or X & Z
- CENTRE OF CIRCLE:- Centre of the circle
- DIAMETER OF CIRCLE:- Diameter required
- NUMBER OF HOLES: Number of Holes.
- ST.ANGLE: - Starting angle that the center of the first hole on the circle.
- END.ANGLE:- Ending angle that the center of the last hole on the circle.

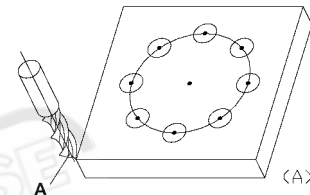

Angle has two directions: counterclockwise and clockwise. “NO.-” Indicates that it is counterclockwise from the start position and “No.+” Indicates it is clockwise from the start position. As the following figure, the ST.ANGLE is 0°, END.ANG is 240°.

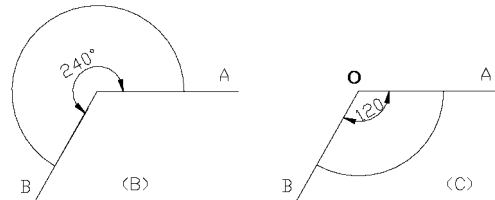

The figure (B) illustrates the arc while angle direction is counterclockwise; figure (C) illustrates the arc while angle direction is clockwise.

As figure (D) illustrates, machine a hole every 45 deg from 45° ~ 225°. Parameters are as the following:

- DIAMETER 40
- ST.ANGLE 45°
- END.ANGLE 225°
- HOL NUM 5

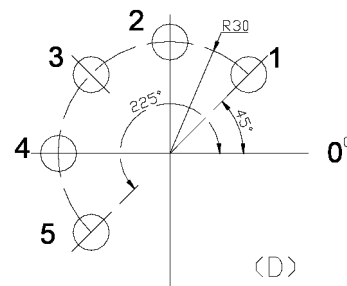

Note: If the ST.ANGLE equals the END.ANGLE, the holes are attributed equally around the whole circumference.

3.1 PITCH CIRCLE HOLE FUNCTION Cont.

Example Steps:

1. Set the display unit to metric in normal "MILL" state;
Move the machine table until the cutting tool is aligned with the center of the circle, then zero X axis and Y axis.
2. Press to display the menu option "Pitch Circle Hole function", then press **F1** to enter Pitch Circle Hole setup.
3. Press until "PCD" is highlighted then press **ENT**.



4. Press **ENT** to place the cursor next to the COORDINATE PLANE: Enter "X Y" then press **ENT** to confirm then move the cursor to CENTRE OF CIRCLE, press **ENT** and enter 0.00 then **ENT** to confirm then to DIAMETER: press **ENT** and enter 40.000 then **ENT** to confirm then to HOL NUM: press **ENT** and enter 5 then **ENT** to confirm then to ST.ANGLE: press **ENT** and enter 45 then **ENT** to confirm then to END.ANGLE: press **ENT** and enter 225 then **ENT** to confirm.
5. Select by pressing **F1** to activate the operation screen.



OPERATION

6. Press **F4** to progress **No. -** anti clockwise to the first hole or **F5** to progress **No. +** clockwise to the first hole. Move the table until the **X&Y** planes are both zero then drill the hole. Press **F4** to progress **No. -** anti clockwise to the next hole or **F5** to progress **No. +** clockwise to the next hole. Progress until all holes have been drilled.
7. Select by pressing **F6** to exit the program.

3.2 BOLT HOLE LINE FUNCTION

Function: DPD-300i series DRO provides BOLT HOLE LINE (BHL) function. This function can simplify the processing of multiple holes whose centers are attributed equally on one line. The following parameters are needed to be entered.



COORDINATE PLANE: Axis to be used.

LINE ANG: Line angle (angle between the line and the positive X axis)





LINE LENGTH: Line distance (distance between the center of first hole and the center of the last hole)

NUM OF HOLES: Number of holes.

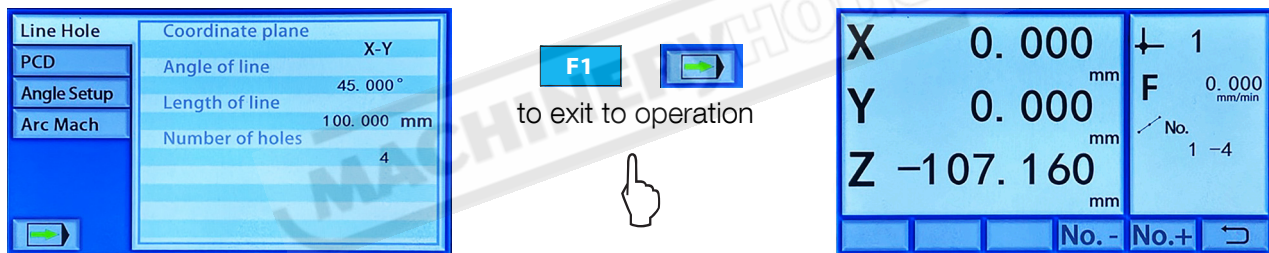
Example Steps:

1. Set the display unit to metric in normal "MILL" state;
Move the machine table until the cutting tool is aligned with the center of the circle, then zero X axis and Y axis.
2. Press  to display the menu option  "Line Hole function", then press **F1** to enter Line Hole setup.
3. Press  until "Line Hole" is highlighted then press **ENT**.



4. Press **ENT** to place the cursor next to the
COORDINATE PLANE: Enter "X Y" then press **ENT** to confirm then  move the cursor
to ANGLE OF LINE: press **ENT** and enter 45.000 then **ENT** to confirm then 
to LENGTH OF LINE: press **ENT** and enter 100.000 then **ENT** to confirm then 
to NUM of HOLES: press **ENT** and enter 4 then **ENT** to confirm
5. Select  by pressing **F1** to activate the operation screen.

OPERATION

6. Press **F4** to progress **No. -** to the left to the first hole or **F5** to progress **No. +** to the right to the first hole. Move the table until the **X&Y** planes are both zero then drill the hole.
Press **F4** to progress **No. -** to the left to the next hole or **F5** to progress **No. +** to the right to the next hole.
Progress until all holes have been drilled.
7. Select  by pressing **F6** to exit the programme.

3.3 ARC MACHINING

This DPD-300i is designed with the ARC function.

It is a waste of time to use a numerical control lathe to process an arc in a simple product or small production run. This function makes it convenient to process an arc with a normal lathe. Parameter "MAX CUT" is the arc length for each process. The smaller the MAX CUT, the more smooth the arc plane and the longer processing time.

A. PROCESS XZ, YZ PLANE

Milling cutters may be flat-bottomed or ball nose cutters.

B. PROCESS XY PLANE.

The DRO provides the 2 modes in processing XY plane. The milling cutter is perpendicular to the machine plane. The DRO has internal Arc machining and external Arc machining for each type. Set the tool radius according to the actual milling cutter when process the XY plane.





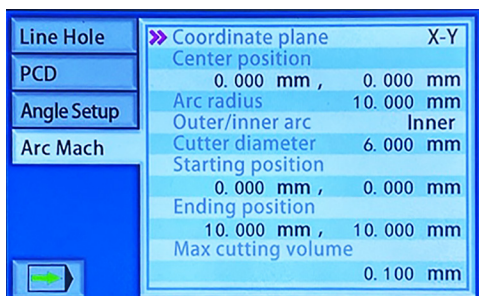

Function: DPD-300i series DRO provides ARC MACHINING function. This function can simplify the processing of machining arcs on two axis. The following parameters are needed to be entered.

- COORDINATE PLANE: Axis to be used.
- CENTRE POSITION: Centre point of the radius
- ARC RADIUS: Radius required
- OUTER or INTERNAL: Radius profile either inner or outer.
- CUTTER DIAMETER: Diameter of the cutter. being used.
- START POS: Starting position
- ENDING POSITION: Radius end position
- MAX CUT VOLUME: Max depth of cut to the next reference points.

Example Steps:

1. Set the display unit to metric in normal "MILL" state;
Move the machine table until the cutting tool is aligned with the center of the circle, then zero X axis and Y axis.
2. Press  to display the menu option  "ARC MACH function", then press  to enter Arc setup.
3. Press  until "ARC MACH" is highlighted then press .



4. Press  to place the cursor next to the COORDINATE PLANE: Enter "X Y" then press  to confirm then press  to move the cursor through the selections using  to select and then  to confirm the selection.
5. Select  by pressing  to activate the operation screen.

3.3 ARC MACHINING Cont.

NOTE: The “Maximum Cutting Volume” must be entered.

OPERATION

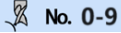
1. The arc machining state is now displayed  in the right hand screen.
2. Move the tool until the X&Y axis displays “0.000”. This means coordinates of the target have been reached.
3. Continue to move the table making sure the X&Y coordinates remain at “0.000”.

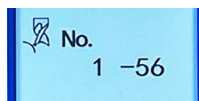
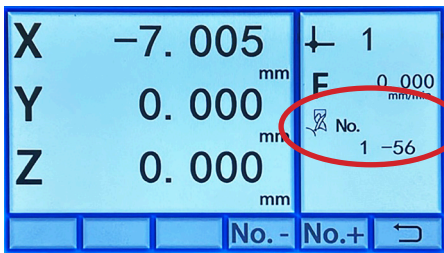

There are 56 points of reference for this radius. Every point needs to have the X & Y coordinates at 0.000 to meet the target radius.







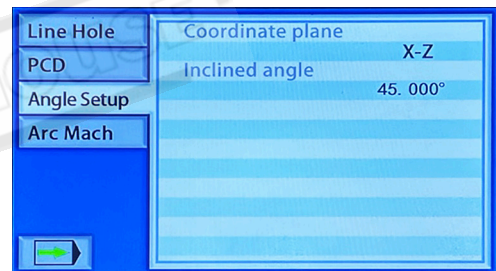





3.4 ANGLE DISPLAY TYPE

There is an angle machining option for the DPD-300i
 Function introduction: To perform the inclined plane machining operation on the selected coordinate plane, that can be used in machining inclined slots or inclined planes.

Setting the angle display type :









Example Steps:

1. Set the display unit to metric in normal “MILL” state;
2. Press  to display the menu option  “Angle Setup”, then press  to select the menu options.
3. Press  until “Angle Setup” is highlighted then press  to select the options
4. Press  to select “Coordinate Plane” then press  to change to either X&Y, or Y&Z and X&Z
5. Press  to confirm select then press  to move down to “Incline Angle”
6. Press  to select then using the keypad enter the angle required.
7. Select  by pressing  to activate the operation screen.

3.5 SETTING THE INPUT IN SDM COORDINATE

The DPD-300i series DRO provides a data entry memory mode known as Sub Data Memory coordinates: This allows from 1-99 preset memory fields to be stored in the DRO; This is handy if multiple components are being machined.

EXAMPLE: SET SDM 1.

1. Set the display unit to metric in normal "ABS" state;
2. Once at the dimension that you want to repeat
3. Select SDM Mode by pressing  Once selected the symbol on the screen will flash.
4. Press  then zero the axis required by pressing   or  then  to confirm the selection and then press  to return to the ABS screen.



OPERATION:

When repeating the operation press  then  and machine until both axis have reached "0.000".

Return to the ABS screen when finished.

NOTE: SDM points can only keep their accuracy if the tooling is not moved. The use of Quick Change Toolposts for lathes and Tool setting fixtures for milling machines may need to be used to ensure accuracy.







Chapter 4 SETUP

4.1 SETTING THE TYPE OF DRO

The **HAFCO DPD-300i** DRO (two axes or three axes DRO) use the same software but their functions have some differences, the DRO type must be set before use.

NOTE: When the DRO is received already fitted to a machine its very possible that the set-up has been completed and will not be required to be setup again.

To setup the DRO:

1. Make sure that all the scales have been connected then, turn on the DRO by using the switch on the back panel
2. To select "Settings"  by pressing **F6**
3. X Axis will be Highlighted. Press **ENT** and the  cursor will appear next to "Display Enable" and begins to flash.
4. Press **ENT** to edit then press  to enable or disable the scale display.
5. Press **ENT** to confirm setting then  down and set "Axis Name"
6. Press **ENT** to edit then use the  button to choose the option of either **X, Y, Z,**
7. Press **ENT** to confirm setting then  down and set "Direction"

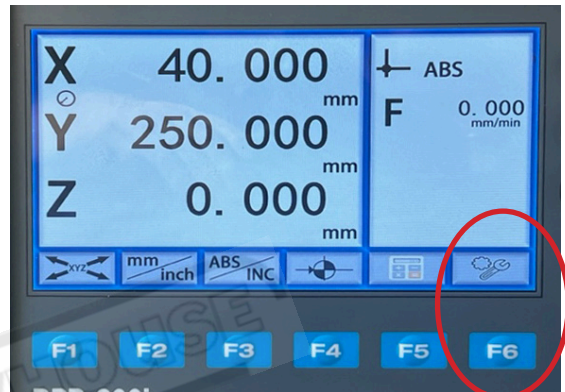

NOTE: The direction of the scales can be set as per the operators decision. Listed below is the nomal scale directions that are set by the factory

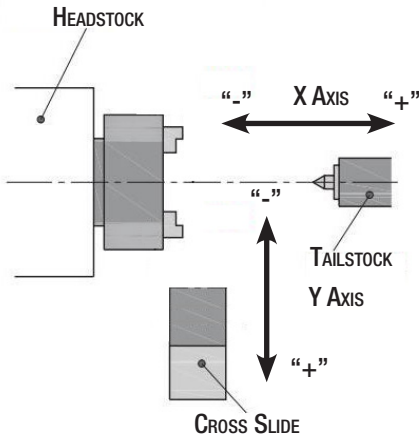

LATHE

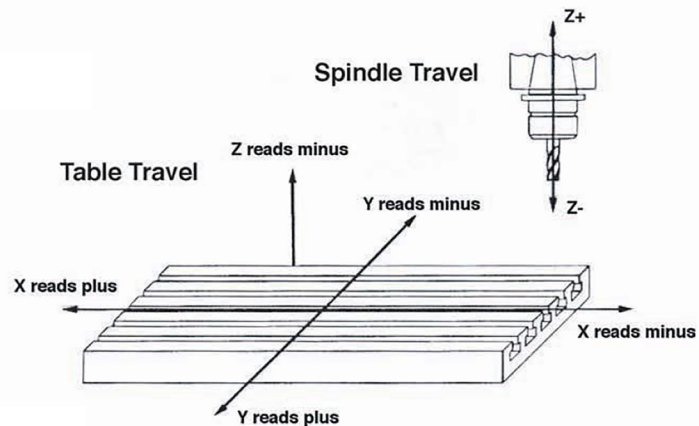

MILL



4.1 SETTING THE TYPE OF DRO Cont.

- 8. Press **ENT** to edit then use the  button to choose the option of either “+” (plus) or “-” (minus) direction.
- 9. Press **ENT** to confirm setting then  down and set “Counting Resolution”

NOTE: The resolution of a scale can be found on the specification details of the scale.

- 10. Press **ENT** to edit then use the keyboard buttons to input the resolution E.g. 0.0050mm
- 11. Press **ENT** to confirm setting then  down and set “Display Resolution”
- 12. Press **ENT** to edit then use the keyboard buttons to input the resolution E.g. 0.0050mm
- 13. Press **ENT** to confirm the setting.

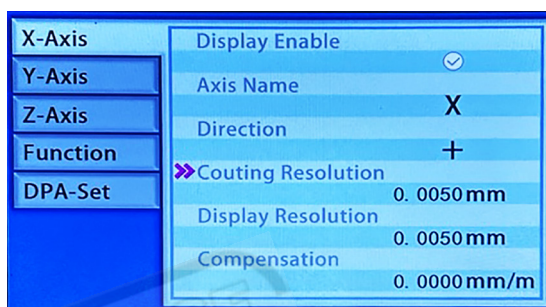

NOTE: The Display and Counting Resolution should be the same. The compensation field should be left at 0.000 for now. The field is only used when a fault in the “ways “ of the machine is found and this field may be used to correct it.

- 14. Press **CE** to exit the edit function for this option. Press  to the “Y Axis” and repeat steps 4 to 14 to set up the “Y Scale” then repeat the same for the “Z Axis”

FUNCTION OPTIONS

The **HAFCO DPD-300i** Digital Readout has three function modes



- 1. Normal
- 2. Lathe
- 3. Mill

The **Normal** function allows for all the special options to be used.

The **Lathe** function allows for only special options for a Turning to be accessed.





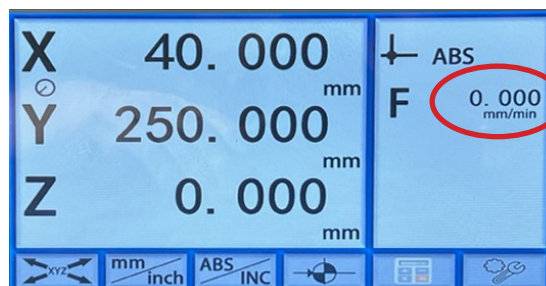
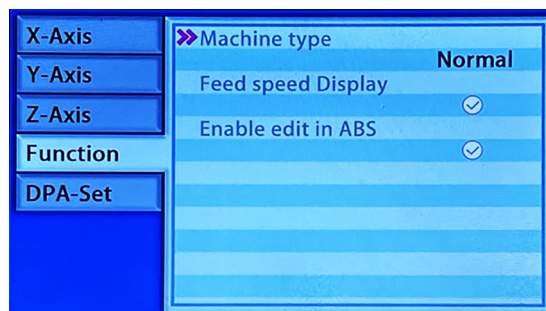

The **Mill** function allows for only special options for a Milling to be accessed.

Feed Speed Display: When this option is ticked then the feed speed of the scale is displayed as mm / min.





- 1. Press **ENT** and the  cursor will appear next to “Machine Type” and begins to flash.
- 2. Press **ENT** to edit then use the  button to choose the option, Normal, Lathe or Mill.



4.1 SETTING THE TYPE OF DRO Cont.

3. Press **ENT** to confirm setting then  down and set "Feed Speed Display".
4. Press **ENT** and the  cursor will appear next to "Feed Speed Display" and begins to flash.
5. Press **ENT** to edit then use the  button to choose the option, (Tick display).
6. Press **ENT** to confirm setting then  down and set "Enable Edit in ABS".
7. Press **ENT** and the  cursor will appear next to "Enable Edit in ABS" and begins to flash.
8. Press **ENT** to edit then use the  button to choose tick or untick the option, (Tick display).

DPA DISPLAY SET



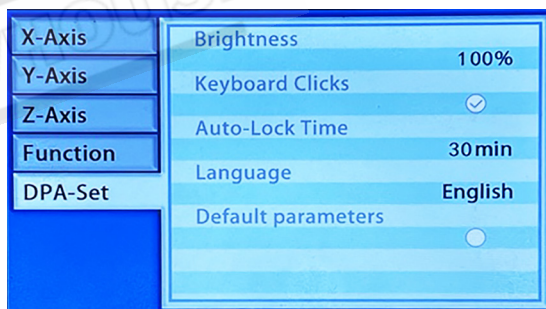



1. Press **ENT** to edit then use the keyboard buttons to input the "Brightnes" of the display E.g. 20% to 100%
2. Press **ENT** to confirm setting then  down and set "Keyboard Clicks"
3. Press **ENT** to edit then use the  button to choose the option, (Tick display makes a "Beep" when ticked, and is silent when unticked).
4. Press **ENT** to confirm the setting then  down and set "Auto Lock Time" (This sets the time before the display dims).
5. Press **ENT** to edit then use the keyboard buttons to input the time amount (E.g. 20mins)
6. Press **ENT** to confirm setting then  down and set "Language".
7. Press **ENT** to edit then use the  button to choose the option, (English, French, Dutch, Spanish)
8. Press **ENT** to confirm setting then press **CE** to exit the edit function. Press **CE** to exit the set up and return to the operation display.



4.2 THE SCALE REFERENCE POINT (ZERO-POSITION) FUNCTION.

Function introduction: The DRO scale or magnetic grating signal begins to count from the preset initial value when the scale reader passes the scale reference point. One hundred coordinates can set one hundred different value points.

Operation Procedures

1. Press  key to access the scale reference point function, call up the reference values of the three coordinates, and  will begin flashing separately.
2. As you move the reader head over the scale, when it passes the reference point, the DRO begins to count, and stop flashing.
All the specified axis pass the scale reference point, the one hundred coordinate tool system completes the operation at the same time;
3. On this plane the reference value of three coordinate systems can be modified follow this method.
4. Press    to start or close the corresponding Zero-Position function.
5. Press  to exit.

4.3 TROUBLESHOOTING

Review the troubleshooting and procedures in this section if a problem develops with your equipment. If additional help with a procedure is required, then contact your distributor.

Note: Make sure you have the model number, before calling.

Symptoms	Possible Cause	Possible Solution
No display	<ol style="list-style-type: none"> 1. Power source failure 2. Damage of fuse 3. Poor 220V power source wiring 4. Inappropriate power voltage. 	<ol style="list-style-type: none"> 1. Power source access 2. Replace the fuse with identical specification 3. The power socket should be good. 4. Check the input voltage is within 100~240 volts
DRO Cover is charged	<ol style="list-style-type: none"> 1. Improper grounding between lathe and digital display. 2. Leakage of Electricity 	<ol style="list-style-type: none"> 1. The lathe shell and digital display shell should ground properly. 2. Inspect the 240V power source
Display value is double	<ol style="list-style-type: none"> 1. Improper setting of the scales resolution 2. Some axle is set as diameter display mode 	<ol style="list-style-type: none"> 1. Set the correct resolution rate 2. Set the radius mode display
No counting	<ol style="list-style-type: none"> 1. Improper contact between the scale and the reader head. 2. No signal output from a scale. 3. Failed counting function 	Exchange with another axle and observe whether the counting is normal; if normal, then the scale has failed. If there is still no counting then the DRO has failed. Have the DRO meter repaired.
Display value is in disorder	<ol style="list-style-type: none"> 1: Disorderly system memory 2. Failure of the scale (grating ruler,) 	<ol style="list-style-type: none"> 1. Implement the system's all clear. 2. Repair or replace the scale (grating ruler)
Incorrect counting	<ol style="list-style-type: none"> 1. Poor precision of the lathe 2. Too fast run speed of the lathe 3. Improper scale mounting 4. Improper resolution is set 5. Improper linear error compensation 6. Faulty scale 	<ol style="list-style-type: none"> 1. Repair the lathe. 2. Reduce the movement speed of the scale. 3. Reinstall scale. 4. Set proper resolution. 5. Set proper linear error compensation. 6. Repair or exchange linear scale.

GROUNDING DIAGRAM

ATTENTION: To avoid possible Electrical Shock !! Please install the DRO's grounding to the earth terminal of the DRO to the machine

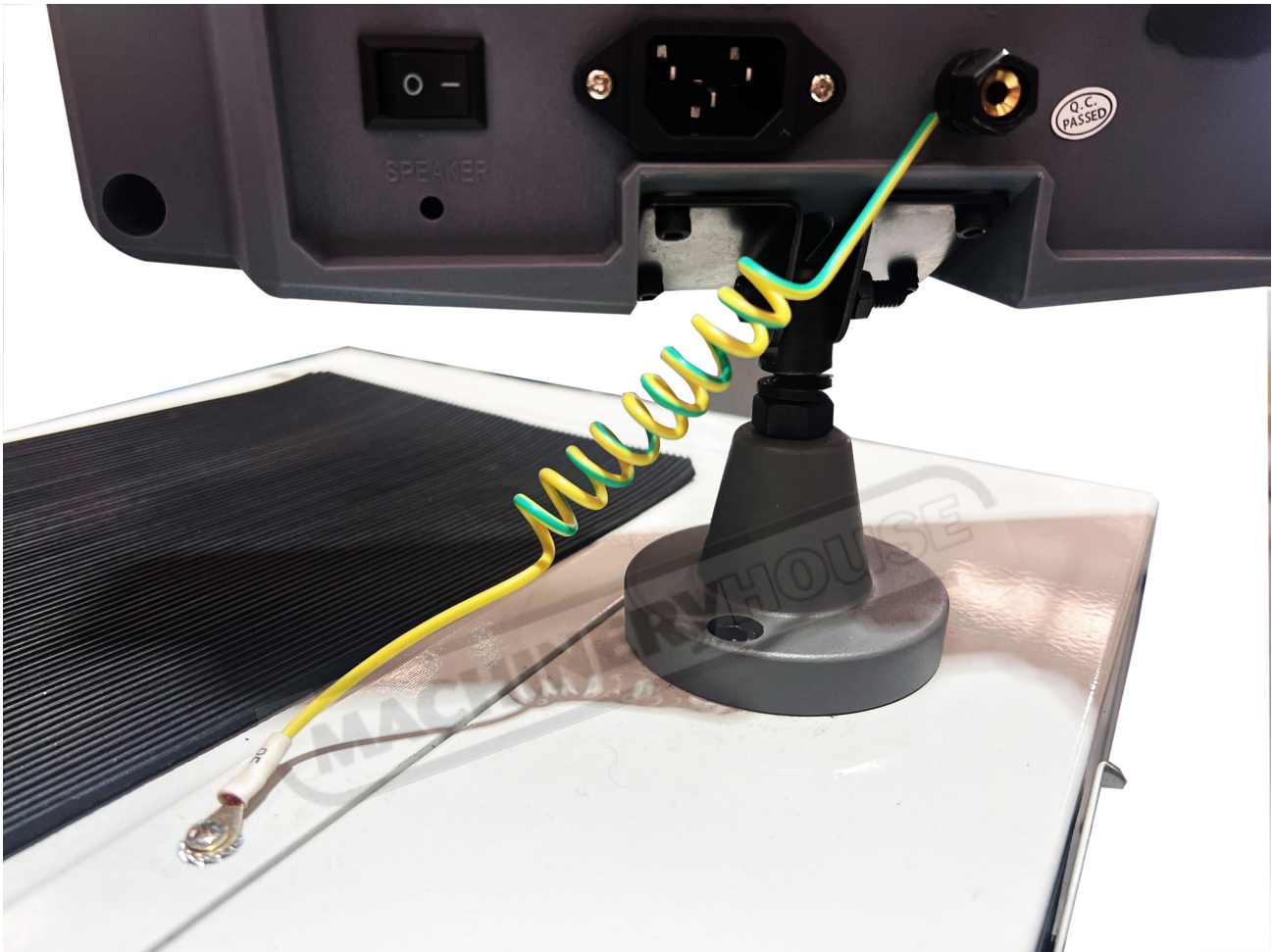
**WARNING!**

*Electricity is dangerous and could cause death
All electrical work must be carried out by a qualified electrician.*